



# KP2200-POWER THYRISTOR

3200-3600 V<sub>DRM</sub>

\*\*\*\*\*

## HIGH POWER THYRISTOR FOR PHASE CONTROL APPLICATIONS

### Features:

- . All Diffused Structure
- . Amplifying Gate Configuration
- . Blocking capability up to 3600 volts
- . High dv/dt Capability
- . Pressure Assembled Device

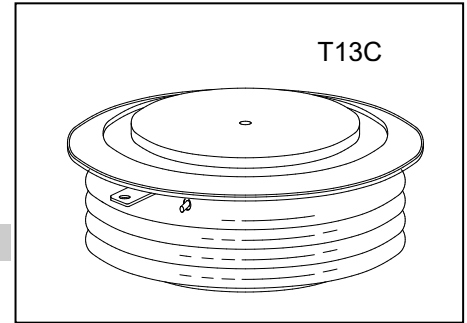

## ELECTRICAL CHARACTERISTICS AND RATINGS

### Blocking - Off State

Device Type	V <sub>RRM</sub> (1)	V <sub>DRM</sub> (1)	V <sub>RSM</sub> (1)
KP2200/32	3200	3200	3400
KP2200/34	3400	3400	3600
KP2200/36	3600	3600	3700

V<sub>RRM</sub> = Repetitive peak reverse voltage  
V<sub>DRM</sub> = Repetitive peak off state voltage  
V<sub>RSM</sub> = Non repetitive peak reverse voltage (2)

Repetitive peak reverse leakage and off state leakage	I <sub>RRM</sub> /I <sub>DRM</sub>	5 mA 150 mA (3)
Critical rate of voltage rise	dv/dt (4)	1000 V/μs

Notes:

- (1) All voltage ratings are specified for an applied 50Hz sinusoidal waveform over the temperature range -40 °C to +125 °C.
- (2) 10 msec. max. pulse width
- (3) Maximum value for T<sub>j</sub> = 125 °C.
- (4) Minimum value for linear and exponential waveshape to 67% rated V<sub>DRM</sub>. Gate open. T<sub>j</sub> = 125 °C.
- (5) The value of di/dt is established in accordance with EIA/NIMA Standard JB/T 8950.2-2013

### Conducting - On State

Parameter	Symbol	Min.	Max.	Typ.	Units	Conditions
Average value of on-state current	I <sub>T(AV)</sub>		2200		A	Sinewave, 180° conduction, T <sub>c</sub> =65°C
RMS value of on-state current	I <sub>TRMS</sub>		3454		A	Nominal value
Peak one cycle surge (non repetitive) current	I <sub>TSM</sub>		35000		A	10.0 msec (50Hz), sinusoidal wave-shape, 180° conduction, T <sub>j</sub> = 125 °C
I square t	I <sup>2</sup> t		6.125x10 <sup>6</sup>		A <sup>2</sup> s	10 msec
Latching current	I <sub>L</sub>		1000		mA	V <sub>D</sub> = 12 V; R <sub>L</sub> = 12 ohms
Holding current	I <sub>H</sub>		200		mA	V <sub>D</sub> = 12 V; I = 2.5 A
Peak on-state voltage	V <sub>TM</sub>		2.0		V	I <sub>TM</sub> =3000A; T <sub>j</sub> =25°C
Threshold voltage, low-level	V <sub>TO</sub>		1.01		V	T <sub>j</sub> =125°C
Slope resistance, low-level	r <sub>T</sub>		0.22		mΩ	1000A to 5000A
Critical rate of rise of on-state current(5)	di/dt		200		A/μs	T <sub>j</sub> =125°C; V <sub>D</sub> = 0.67 V <sub>DRM</sub> ; f=50Hz; I <sub>TM</sub> =3000A

**Gating**

Parameter	Symbol	Min.	Max.	Typ.	Units	Conditions
Peak gate power dissipation	$P_{GM}$		20		W	
Average gate power dissipation	$P_{G(AV)}$		4		W	
Gate-trigger current	$I_{GT}$		200		mA	$V_D = 12\text{ V}; R_L = 3\text{ ohms}; T_j = +25\text{ }^\circ\text{C}$
Gate- trigger voltage	$V_{GT}$	0.7	3.0		V	$V_D = 12\text{ V}; R_L = 3\text{ ohms}; T_j = +25\text{ }^\circ\text{C}$
Peak negative voltage	$V_{GRM}$		5		V	

**Dynamic**

Parameter	Symbol	Min.	Max.	Typ.	Units	Conditions
Delay time	$t_d$		3.0	2.5	$\mu\text{s}$	$I_{TM}=100\text{A}; V_D=67\%V_{DRM}$ Gate pulse: $V_G=30\text{V}; R_G=10\text{ohms};$ $t_r=0.1\mu\text{s}; t_p=20\mu\text{s}$
Turn-off time (with $V_R = -5\text{ V}$ )	$t_q$			600	$\mu\text{s}$	$I_{TM} = 2000\text{A}; di/dt = -10\text{A}/\mu\text{s};$ $V_R = 100\text{V}; dv/dt = 30\text{V}/\mu\text{s};$ $V_D = 67\%V_{DRM}; T_j = 125\text{ }^\circ\text{C}$
Reverse recovery charge	$Q_{rr}$				$\mu\text{C}$	$I_{TM}=2000\text{A}; di/dt=-10\text{A}/\mu\text{s};$ $V_R=100\text{V}; T_j=125\text{ }^\circ\text{C}$

**THERMAL AND MECHANICAL CHARACTERISTICS AND RATINGS**

Parameter	Symbol	Min.	Max.	Typ.	Units	Conditions
Operating temperature	$T_j$	-40	+125		$^\circ\text{C}$	
Storage temperature	$T_{stg}$	-40	+140		$^\circ\text{C}$	
Thermal resistance - junction to case	$R_{\Theta(j-c)}$		0.011		$^\circ\text{C}/\text{W}$	Double sided cooled
Thermal resistance - case to heatsink	$R_{\Theta(c-s)}$		0.003		$^\circ\text{C}/\text{W}$	Double sided cooled
Mounting force	F	33	37	35	kN	
Weight	m			1.1	kg	

\* Mounting surfaces smooth, flat and greased

